

Drives







PGD / PGD-Ai -Pulse Geared Drive-

Product Information

General Information

- Conformance: CE, RoHS, IP54
- Certifications: ETL Listed to UL 1004-1 & UL 1004-6
- Mounting: M5 x 7 mm
- Shaft Diameter: 16 mm
- Key: 5 x 5 x 25 mm
- Cable Length¹: 600 mm (SENERGY) / 1000 mm (SENERGY-Ai)
- Motor Connection: 9-Pin JST (SENERGY) / 4-Pin M8 (SENERGY-Ai)
- Duty Cycle: 0.5 sec ON / 0.5 sec OFF minimum
- Operation: Continuous at rated load/current without overheating



Compatible Control Technologies	
SENERGY	SENERGY - Ai
 EQUBE	 EQUBE
 EZQUBE	 CONVEYLINX
 CONVEYLINX	 MOTIONLINX

Technical Data

	ECO Mode	BOOST Mode	BOOST-8 Mode
Voltage	DC24V		
Nominal Output	40W	50W	50W
Rated Current	2.5A	3.5A	3.5A
Starting Current	3.0A	5.0A	8.0A
Ambient Temperature	-10 ~ 40°C (14 ~ 104°F) (No condensation)		
Ambient Humidity	10 ~ 90% RH (No condensation)		

Weight Table (kg)

Gear Box	Reduction Ratio	Weight
3 stage	67, 45, 33, 27	1.5
2 stage	18, 15, 11, 9	1.2

¹ See Ordering Information on page 61 for Motor Extension Cables



Characteristics Data

Nominal Gear Ratio	Actual Gear Ratio	Gear Box	ECO Mode				BOOST & BOOST-8 Mode ^{1,2}							
			Output Shaft Speed (rpm)	Torque(N-m)		Current (A)		Output Shaft Speed (rpm)	Torque(N-m)			Current (A)		
				Rated	Starting	Rated (max)	Starting		Rated	BOOST Starting	BOOST-8 Starting	Rated (max)	BOOST Starting	BOOST-8 Starting
67	67.2	3 stage	8.5 ~ 86.7	4.4	24.4	2.5	3.0	8.5 ~ 62.7	8.0	31.8	36.1	3.5	5.0	8.0
45	45		12.8 ~ 129.0	2.9	16.3			12.8 ~ 93.3	5.4	21.3	24.3			
33	33		17.4 ~ 176.3	2.1	12.0			17.4 ~ 127.5	3.9	15.6	17.7			
27	27		21.3 ~ 215.1	1.7	9.8			21.3 ~ 155.5	3.2	12.8	14.5			
18	18.3	2 stage	31.4 ~ 317.3	1.2	6.6			31.4 ~ 229.5	2.1	8.6	9.8			
15	15		38.4 ~ 387.2	0.9	5.4			38.4 ~ 280.0	1.8	7.1	8.1			
11	11		52.4 ~ 528.9	0.7	4.0			52.4 ~ 382.5	1.3	5.2	5.9			
9	9		64.0 ~ 645.3	0.5	3.2			64.0 ~ 466.6	1.0	4.2	4.8			

¹ Rated Torque and Tangential Force values are the same for BOOST and BOOST-8

² BOOST-8 performance only available with EZ-24HTB, ConveyLinX-HTF, ConveyLinX-Ai2, and MotionLinX-Ai controllers

Dimensions (mm)

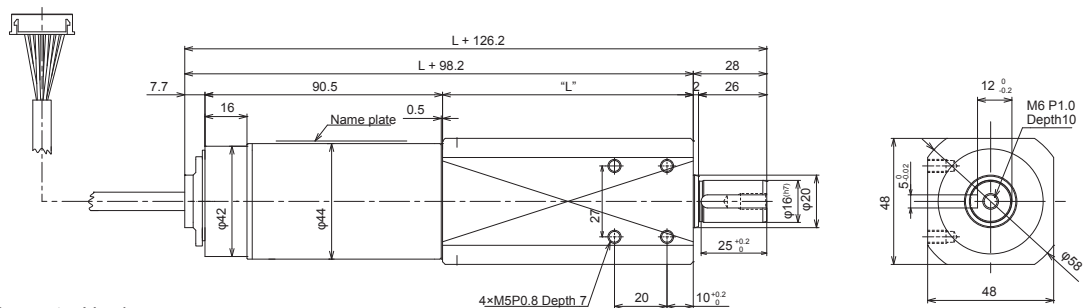

Connector Versions

SENERGY
JST

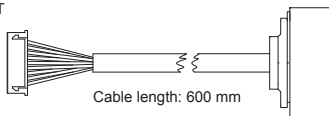

SENERGY-Ai
M8-4pin

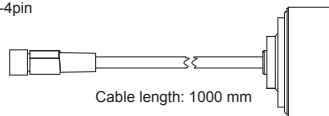

"L" dimension

2-stage	93.5 mm
3-stage	116.9 mm

